

PRODUCT CHART

TP-1-30-03-C

TP Contactors are intermittent duty bidirectional contactors suitable for operation under DC or AC voltages up to 3600V, in both railway or industrial applications, typically used in precharge function

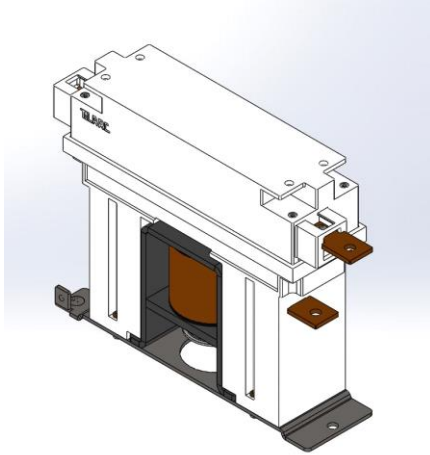

General Information

Number and type of poles	1NO
Overall dimensions dwg	Z00104A
3D drawing	Z00104A.stp
Electrical scheme	ES00009A
Maintenance Manual	MM00003A
Validation Chart	VR00008
Blow out type	twister
Type of arc chute	N/A
Auxiliary contacts chart	Crouzet PBX-T

Electrical Data

Rated Operational Voltage	Ue	3600	Vdc/ac
Rated insulation voltage	Ui	4800	Vdc
Rated impulse withstand voltage	Uimp	25	kV
Conventional free air thermal current at 40°C (per pole)	Ith 40	30	A
Conventional free air thermal current at 75°C (per pole)	Ith 75	25	A
Rated operational current (per pole)	Ie	20	A
Rated short time withstand current (per pole)	Icw/t	7/100	kA/ms
Peak short time withstand current (per pole)	Icw	7	kA
Max breaking current DC t=15ms (per pole)	Ibc	35	A
Max breaking current AC cosφ = 0,8 (per pole)	Ibc	80	A
Max making current DC t=15ms (per pole)	Uimplmc	2,2	A
Max making current AC cosφ = 0,8 (per pole)	I _{mc}	2,2	A
Electrical endurance @Ue/Ie		8000	cycles

Notes:

Mechanical and Environmental Data

Pollution degree / overvoltage category	EN 50124	PD3/OV3
Component category	EN 50124	A2/C2
Shock and vibration	IEC 61373	Cat 1 / class B
Mechanical endurance	cycles	2mio
Closing/opening time at Vc nom	msec	ms
Weight	kg	2,5
Max altitude without derating	m asl	2000
Operational temperature (IEC 50125-1)	IEC 50125-1	-40°C to +75°C
Stocking temperature		-50°C to +85°C

Non-Metallic Materials

BMC RF9	410g	
Latamid	650g	
Primef	0g	

Spares Part Numbers

Arc chute (per pole)	N/A
Arching contacts (per pole)	N/A
Main contacts (per pole)	N/A
Aux contacts type F	Y00002A
Aux contacts type C	Y00001A

Insulation Distances

	x	y	z
from metallic parts	50	50	50
from insulated parts	50	30	20

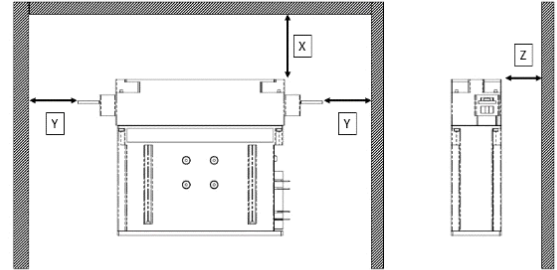

Control Coil Chart (per coil/pole)

Coil operating range:		Vc -30% +25%		Closing Power at Vc:		70W		Holding Power at Vc:		N/A	
Suffix	Vc	Coil P/N	Coil Ω	Suffix	Vc	Coil P/N	Coil Ω				
A	24Vdc	Z00060A	6,7	D	72Vdc	Z00063A	64,6				
B	36Vdc	Z00061A	16,7	E	110Vdc	Z00064A	155				
C	48Vdc	Z00062A	32	F	220Vdc	N/A	N/A				

Note: in multipole versions coils are connected in parallel, auxiliary contacts shall be connected in series

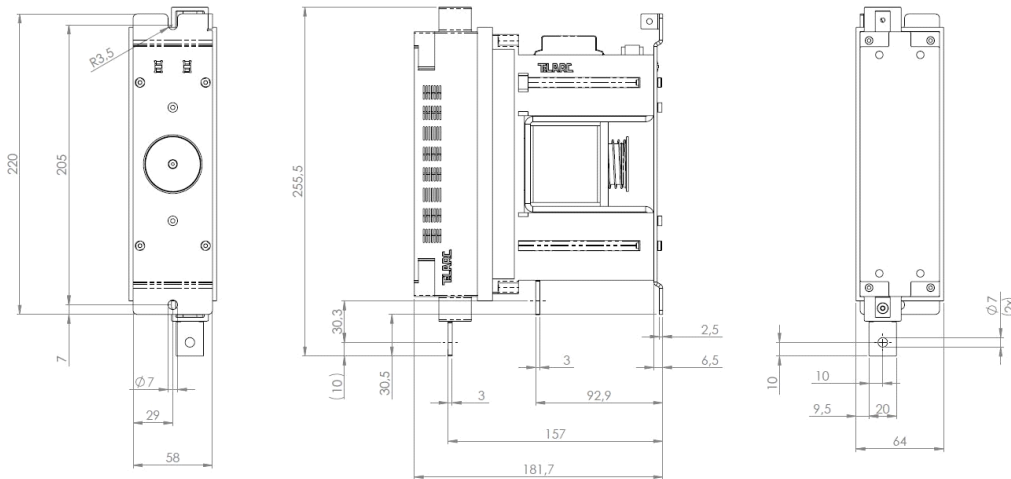

Ordering Information

Order placement requires a full 15 digits part number. The mainpart number TP-1-30-03-C shall be followed by: the coil suffix, the installation orientation suffix H/V, the 2digit aux suffix and the 3 digit revision suffix

Example	TP-1-30-03-C	-A	H	-2F	-001
Main part number					
Coil Suffix (see Coil Chart for details)					
Installation orientation suffix (= „H“ for bottom fixing / „V“ for wall fixing)					
Aux suffix (=number of 1NO+1NC contacts blocks + „C“ for screw / „F“ for faston terminals)					
Revision suffix					

Example: 1NO pole TP contactor, 3600V, 30A Ith, C-terminals, 24Vdc coil, Horizontal installation, 2NO+2NC faston term. Aux contacts, rev 01